

EnvVCA

4ms Company

User Manual 1.0 – October 30, 2022

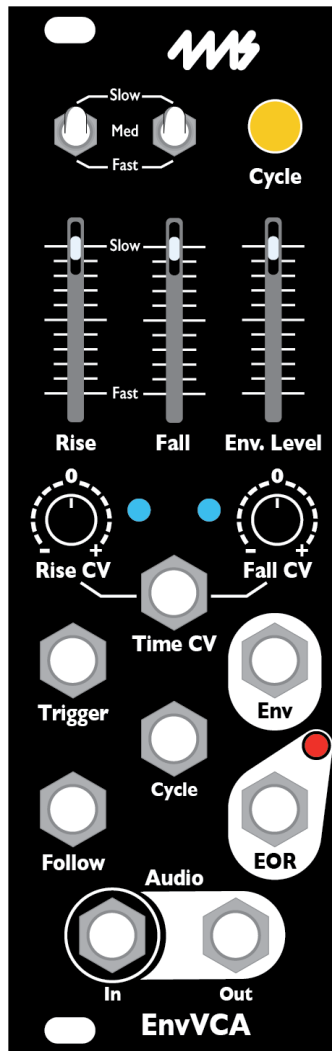

The **EnvVCA** is an analog envelope generator, slew limiter, and VCA.

EnvVCA features:

- Versatile linear envelope generator/LFO
- Low-noise, low-distortion, DC-coupled exponential VCA
- 100% analog
- Sliders, switches and Time CV jack control Rise and Fall times
 - 100 μ s (10kHz) to over 30 minutes
 - With sliders and switches only: ~1.25ms (800Hz) to over 2 minutes
 - Independent attenuverters for Rise and Fall time
 - Blue/red LEDs indicate strength and polarity
- Cycle button for looping envelopes (LFO)
- Trigger input jack fires a one-shot envelope
- Cycle gate input jack toggles cycling
- EOR (End of Rise) gate output can be used to chain and sequence events
- Env Level slider controls output level of the Env jack without changing the VCA volume
- Audio In and Out jacks for passing audio or CV through the VCA
- VCA gain internally connected to envelope output
- Follow input jack allows for slew limiting, sustain (ASR), and exotic filtering effects
- Re-trigger jumper allows for re-triggering during rise phase

Table of Contents

Setting up your EnvVCA	2
Controls and Jacks	3
Patch: Making Notes	5
Making Notes (basic)	5
Making Notes Using External Triggers.....	5
Patch: Ratcheting	6
Ratcheting.....	6
Advanced Ratcheting.....	6
Rise and Fall Time Ranges	7
Creating Envelopes (Trigger, Cycle, Follow).....	7
Triggering with RETRIG Jumper Off (Factory Default)	7
Triggering with RETRIG Jumper On.....	7
Cycle Button/Jack	8
Follow Jack with Gates.....	8
Fundamentals of the Follow Jack.....	9
Creating ASR and ADSR Envelopes	9
ASR envelope	9
ADSR envelope.....	10
Audio filter.....	11
Portamento/glide	11
Generating Exponential and Logarithmic Envelopes.....	11
RETRIG Jumper.....	12
VCA Min Gain Trim pot	12
Electrical and Mechanical Specifications	12

Setting up your EnvVCA

1. Power off your Eurorack system.
2. On the back of the **EnvVCA** you will see a 10-pin header. The 10-pin header connects to a Eurorack power header using the included power cable. Connect the 16-pin end of the power cable to a 16-pin Eurorack power header on your power supply distribution board and the 10-pin end to the **EnvVCA** with the red stripe on the power cable oriented towards the bottom of the module.
3. Using the included screws, securely attach the **EnvVCA** to the rails of your case.
4. Power on your Eurorack system.

*Note: The **EnvVCA** is reverse-polarity protected, but incorrectly connecting any module in any system can damage other modules on the power bus.*



Controls and Jacks



Cycle

Cycle Button and Cycle Jack

The **Cycle** button toggles the cycling state. When cycling, the **EnvVCA** behaves like an LFO, with an output waveform that continuously rises and falls. The button illuminates orange to indicate the module is cycling. Note that pressing this button does not reset or alter an envelope that's already rising or falling.



Cycle

The **Cycle** jack toggles the cycle state using a gate source. If the **Cycle** button is off, a given gate signal will initiate cycling for as long as the gate is held high. If the **Cycle** button is on, then the functionality is inverse and the gate signal will cease any cycling for as long as the gate is held high. See [Using the Cycle Button](#) on page 8 for more information.

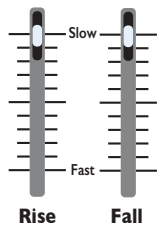

Rise/Fall Sliders

The **Rise** and **Fall** sliders control the rise and fall times of the envelope. Shifting a slider up makes the rise or fall portion slower, and down makes it faster. Each slider has a white light that indicates the current stage and output voltage of the envelope. When the envelope is in the rise stage, the **Rise** slider light will increase in brightness until the envelope hits its maximum. Once the peak is reached, the **Rise** light will turn off and the **Fall** light will turn on, decreasing in brightness as the envelope falls.



Rise/Fall Switches

The **Rise/Fall** switches select the overall range of the sliders. Each slider has its own switch with three positions: **Fast**, **Med**, **Slow**.

When the switch is flipped to **Fast**, the envelopes go well into the audio range, allowing for classic AM, FM, and other fast modulation effects.

The middle position (**Med**) is designed for typical musical tempos, and can be useful when using the VCA to make notes at common BPMs.

The **Slow** position is geared for gradual fades and other slow LFO-style modulations.

See the [Rise and Fall Time Ranges](#) chart on page 7 for more information.

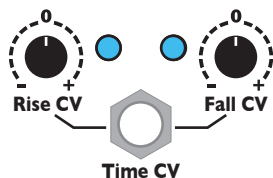

Time CV Jack and Rise/Fall CV Knobs

The **Time CV** jack modulates the **Rise** and **Fall** times of the envelope. The jack feeds two knobs: **Rise CV**, and **Fall CV**. Each of these knobs is an attenuverter (short for "attenuating inverter") and controls how much the control voltage on the **Time CV** jack will effect either the rise time or the fall time.

Turning an attenuverter knob to the right of center means that a positive voltage on the **Time CV** jack will *lengthen* the rise/fall time and a negative voltage will *shorten* the rise/fall time.

Turning a knob to the left of center gives the opposite effect, meaning that a positive voltage on the **Time CV** jack will *shorten* the the rise/fall time, while a negative voltage will *lengthen* these durations.

The farther you turn the knob from center in either direction, the more effect incoming CV will have. When the knob is centered, the signal on the **Time CV** jack will have no effect on the rise or fall time.

Next to each knob is a light which indicates the strength and polarity of the modulation. The light will turn blue when the rise or fall time is being lengthened by CV, and red when the time is being shortened. The brighter the light, the more of an effect the CV is having. When the light is off, the **Time CV** jack has no effect on the envelope time.

See [Generating Exponential and Logarithmic Shapes](#) on page 11 for more information.



Env Jack

The **Env** jack outputs the envelope. The level (amplitude) is attenuated by the **Env. Level** slider.

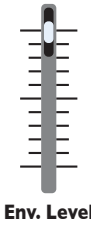

Env. Level Slider

The **Env. Level** slider attenuates the envelope output on the **Env** jack. When the slider is at the bottommost position, the **Env** jack will output 0V. In the topmost position, the **Env.** jack will output an envelope between 0V and 10V. The light on the **Env. Level** slider indicates the amplitude of the envelope on the jack.

Note that the slider does not effect the envelope going to the internal VCA. If, for example, the **Env** jack is patched to a modulation input on an external module while audio is running through the VCA, the slider can be used to control the amount of modulation without changing the audio level.



EOR Output Jack

The **EOR** jack outputs a gate that goes high when the rise stage ends, which is when the fall stage begins. The gate remains high as long as the envelope is falling and goes low when the envelope completes. The gate will stay low when the envelope is not running, and the light will shine orange when the **EOR** output is high.

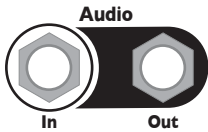

Audio In and Out Jacks

The **Audio In** and **Out** jacks are the input and output of the VCA. The envelope output (pre-level slider) is internally routed to the CV input of the VCA. When the envelope is stopped or at 0V, the **Out** jack will output silence. As the envelope rises, the signal will get louder until it becomes as loud as the input signal at the peak of the envelope. As the envelope falls, the signal will fade back to silence.



Trigger Jack

The **Trigger** jack requires a trigger of at least 2V to start an envelope. If there is no envelope in progress, then a trigger will initiate a single complete envelope. If the envelope is rising when a trigger is received, then the trigger is ignored (unless the **RETRIG** jumper is installed, see below). If the envelope is falling when a trigger is received, it will begin rising from its current voltage.

On the back of the module is a **RETRIG** jumper. When this jumper is installed, the envelope will immediately jump to 0V and start rising any time a trigger is received. This can cause a click on the VCA output, so the jumper is not installed at the factory.



Follow Jack

The **Follow** jack is the input of a slew limiter, and can also be used for complex envelope generation, exotic audio filtering, and envelope following.

Whenever the internal envelope is not triggered or cycling, the envelope output will rise or fall in order to match the voltage level present on the **Follow** jack. However, the rate of rise and fall times is limited by the positions of the **Rise/Fall** sliders and the CV amounts. That is, the envelope output will try to “follow” the signal present on the **Follow** jack, but it can only rise and fall as fast as the envelope would rise/fall if it were to be triggered. Since “slew” is the rate of change, we call this “slew limiting”.

Slew limiting can be used to create complex envelopes (ASR, ADSR, etc) by timing the signal on the **Follow** and **Trigger** jacks. See [Fundamentals of the Follow Jack](#) on page 9 for more information.

Patch: Making Notes

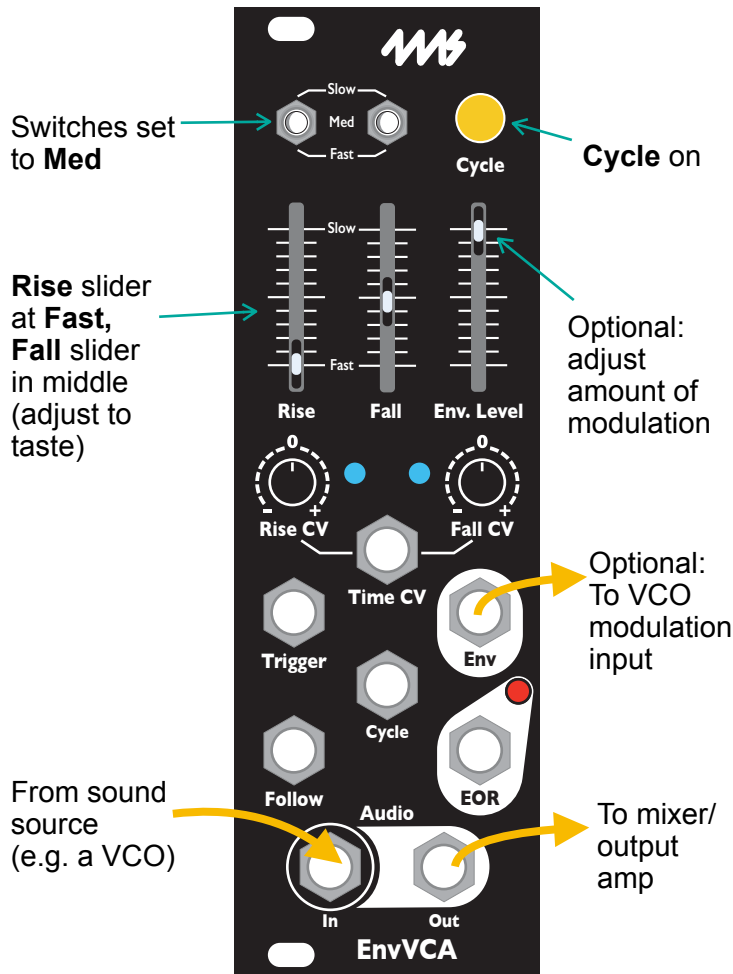

Making Notes (Basic)

Patch a sound source into the **Audio In** jack, and patch the **Audio Out** jack to your mixer or amp so you can hear it on speakers or headphones. When choosing the sound source, try to find something that makes a continuous tone or drone, such as a VCO like the **Ensemble Oscillator**.

When **Cycle** is on (button is shining orange), you should hear notes being played at a steady tempo. The notes should have a sharp attack (quick fade-in) and longer decay (slower fade-out).

Try moving the **Rise** slider up and listen to how the sound fades in more slowly. Then move the **Fall** slider down and hear how the fade-out gets faster. Continue to experiment with the slider positions, listening to how the sound and tempo changes. Try flipping the switches to **Fast** and hear how much faster the envelope gets.

Next, patch the **Env** jack to a modulation input on the sound source. For example, if you're using the **Ensemble Oscillator**, try patching it to the **Warp** jack. For other VCOs, try a PWM or wave-shaper input. Adjust the **Env. Level** slider to control the amount of modulation. When the slider is all the way down, you should have no modulation.

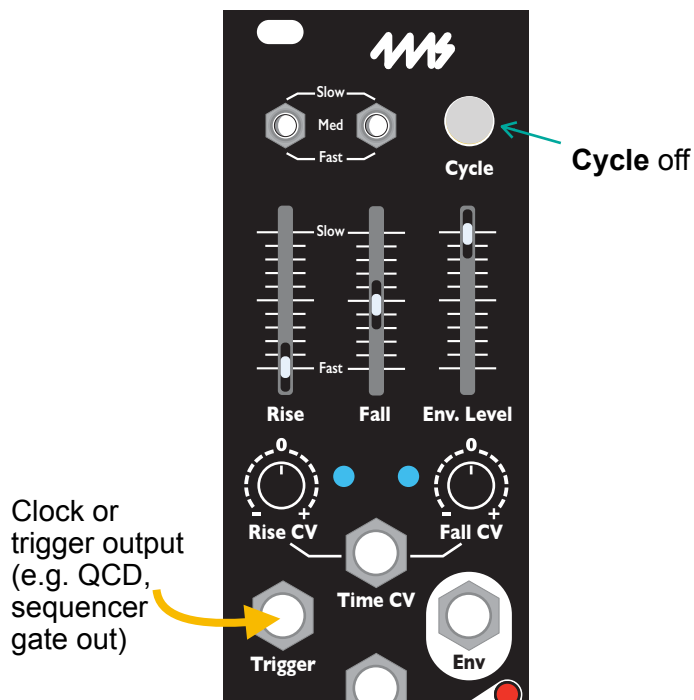

Making Notes Using External Triggers

So far in this patch, the tempo of notes has been linked to the rise and fall times of the envelopes. It's not possible, for example, to have short, quick notes at a slow tempo. By turning **Cycle** off, we can use the **Trigger** jack to control the tempo with an external module.

See the patch on the left. Press **Cycle** to turn it off. The sound should stop. Patch a clock or trigger sequence into the **Trigger** jack. You could use the output from a clock module like the **QCD**, **RCD** or **SCM**, or perhaps the gate output of a sequencer. You could even use an LFO waveform such as a sine wave, as long as the signal peaks are greater than 2V.

When the **Trigger** jack receives a trigger, the envelope will fire one time. Play with the external module's tempo to hear how the notes keep their shape at all tempos. You can even make the notes "run together" by setting the tempo faster than the note duration.

Rise and Fall Time Ranges

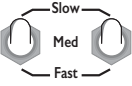
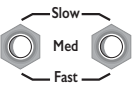
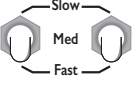
Switch Position	Slider Range (total env. time)	Max Range with CV (total env. time)	Use Cases
 Slow	5 min. to 1.5 sec.	~30 min. to 300Hz	Gradual, slow fades or modulation changes occurring over the course of a long time.
 Med	20 sec. to 18Hz	~30 min. to 1kHz	Generally suited for typical musical tempos. Useful for making notes, from snappy percussive sounds to long decays. The slower slider settings approach LFO ranges.
 Fast	2.5Hz to 800Hz	~30 min. to 10kHz	Good for FM, AM or other audio-rate modulation. Snappy attacks and sharp decays.

Because of its analog nature, the maximum and minimum rise and fall times vary from unit to unit. The table above shows typical values. The rise and fall times will not necessarily be equal when the sliders are in the same position. For precisely equal rise and fall times, manual adjustment is usually needed.

Note that the switch positions have little effect on the range obtained by using CV. This is intentional, to allow external modules control over the full range.

Creating Envelopes (Trigger, Cycle, Follow)

There are four ways to generate an envelope with the **EnvVCA**: using the **Trigger** jack, the **Cycle** button, the **Cycle** jack, or the **Follow** jack.

The **Trigger** jack starts an envelope when it receives a trigger. It only responds to rising edges, that is, when the voltage rises through 2V. Figure 1 shows how a long or short pulse will cause identical envelopes since the pulse width and falling edge of the signal are ignored.

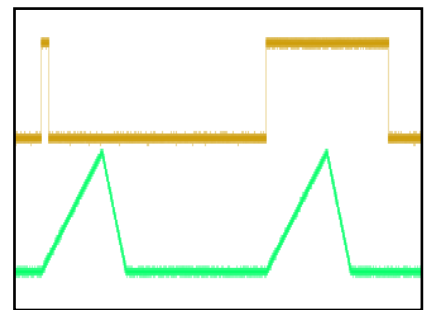

Figure 1: Trigger jack pulse width does not change Env output.

Triggering with RETRIG Jumper Off (Factory Default)

If the envelope is already rising when a trigger is received, then the trigger is ignored (unless the **RETRIG** jumper is installed). If the envelope is falling when a trigger is received, it will begin rising from its current voltage. Figure 2 demonstrates this: the fifth and seventh triggers occur while the envelope is falling and cause it to begin rising mid-fall. The rest of the triggers occur while the envelope is rising and are ignored.

Triggering with RETRIG Jumper On

Figure 3 shows how the **RETRIG** jumper changes the behavior. Regardless of what stage the envelope is in, a trigger always resets it to zero and begins rising. The sharp transition to 0V can cause a click when used with audio, so the jumper is not installed by default.

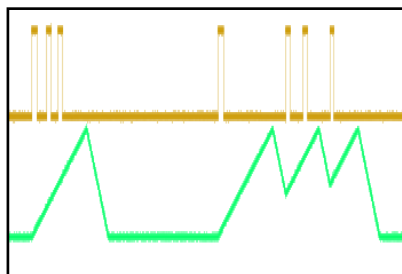

Figure 2: RETRIG jumper off. Triggers on rise stage have no effect. Triggers on fall stage switch to rising.

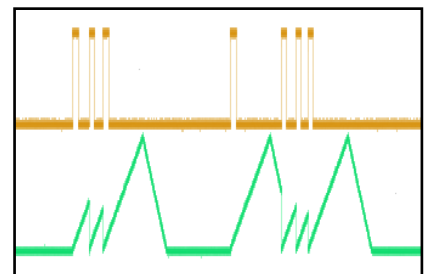

Figure 3: RETRIG jumper installed. Triggers always restart the envelope.

Cycle Button/Jack

The **Cycle** button is a simple way to initiate an envelope. When the button is on, envelopes will cycle continuously. The button is latching, so pressing it once will make the module output envelopes until you press the button again. Once an envelope begins, pressing the **Cycle** button again will not immediately stop the envelope. Instead, the envelope will stop after finishing its fall stage.

The **Cycle** jack toggles the cycling state when a gate is received. It's utilized in tandem with the **Cycle** button. If the button is initially off, a gate signal at the **Cycle** jack will toggle it on. If the button is initially on, a gate at the jack will toggle it off. The **Cycle** button will shine orange whenever the combination of the **Cycle** jack and **Cycle** button causes the envelopes to cycle.

In Figure 4, the **Cycle** button is initially off, and the incoming gate signal on the **Cycle** jack causes the envelope to cycle for as long as the gate is high. In this case, as the pulse width of the gate signal gets wider, the **EnvVCA** outputs more cycles.

Figure 5 shows the opposite state; the **Cycle** button is initially on, so the incoming gate signal stops the cycling for as long as the gate is high. In this case, as the pulse width of the gate signal gets wider, there are longer pauses between groups of envelopes.

Note that the first pulse in Figure 5 does not stop the envelopes, and the three rapid pulses in Figure 4 only cause one envelope. This illustrates an important aspect of the **EnvVCA**: the state of the **Cycle** jack and button only matter when the envelope is stopped (at 0V). Any combination of gates and button presses while the envelope is running have no effect; it's only when the envelope finishes running that the **Cycle** jack or button can make it cycle again.

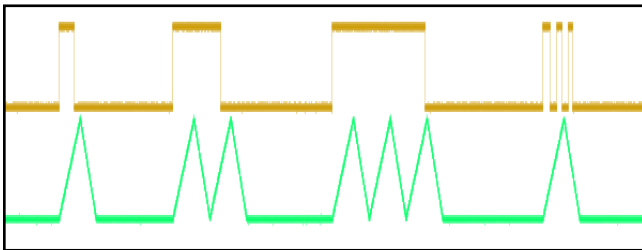

Figure 4: When Cycle button is off, high gate on Cycle jack makes envelope run.

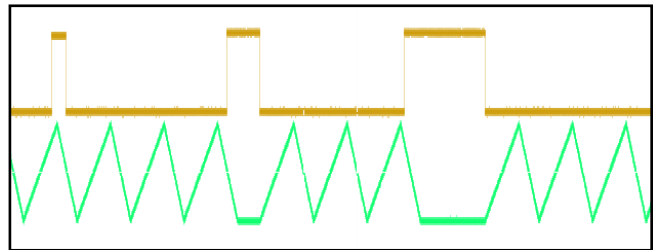

Figure 5: When Cycle button is on, high gate on Cycle jack makes envelope stop.

Follow Jack With Gates

Figure 6 illustrates the use of gates on the **Follow** jack. A gate signal will cause the envelope to rise as long as the gate is high. When the gate goes low, the envelope will fall.

The fourth gate in Figure 6 shows that if the gate is held high while the envelope reaches its maximum, the envelope will hold (sustain) until the gate is released. This is an easy way to create an ASR envelope (Attack Sustain Release).

The short bursts of pulses at the end illustrate how the **Follow** jack can be used to create complex envelope shapes using only a sequence of gates.

The **Follow** jack can be used with more than gates, see [Fundamentals of the Follow Jack](#) for a detailed discussion.

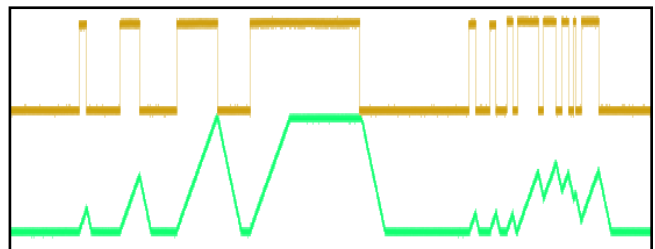

Figure 6: Sending gates into the Follow jack. When the input gate goes high, the envelope rises; when the input goes low, the envelope falls.

Fundamentals of the Follow Jack

The **Follow** jack causes the envelope to rise or fall in order to “follow” the signal on the jack. There are two basic rules that govern this behavior:

Rule 1: If the voltage on the **Follow** jack is greater than the envelope voltage, the envelope will rise; if the voltage on the **Follow** jack is less than the envelope voltage, the envelope will fall.

That is, the envelope will always “seek” the **Follow** signal: it will go up if the **Follow** signal is higher, and it will go down if the **Follow** signal is lower. This is where the term “follow” originates.

Rule 2: The envelope can only rise and fall at the speed set by the **Rise/Fall** controls and CV.

This means that if the **Follow** jack suddenly jumps up (for example, when a gate is applied), the envelope will try to follow that jump by rising, but it can only rise as fast as the controls allow it. The rate of change, or slew, is limited, thus we call the **Follow** circuit a “slew limiter”.

Note that the term “envelope voltage” in Rule 1 refers to the internal envelope voltage, before the **Env. Level** slider and **Env** jack output driver. Internally, the envelope has a maximum of 5V and minimum of 0V, which is why the **Follow** jack only responds to voltages from 0V to 5V. The **Env** jack’s output driver doubles the internal voltage, so a 5V internal envelope corresponds to approximately 10V envelope on the jack.

Armed with these two basic rules, we can now showcase some advanced uses for the **Follow** jack in the following sections.

Creating ASR and ADSR Envelopes

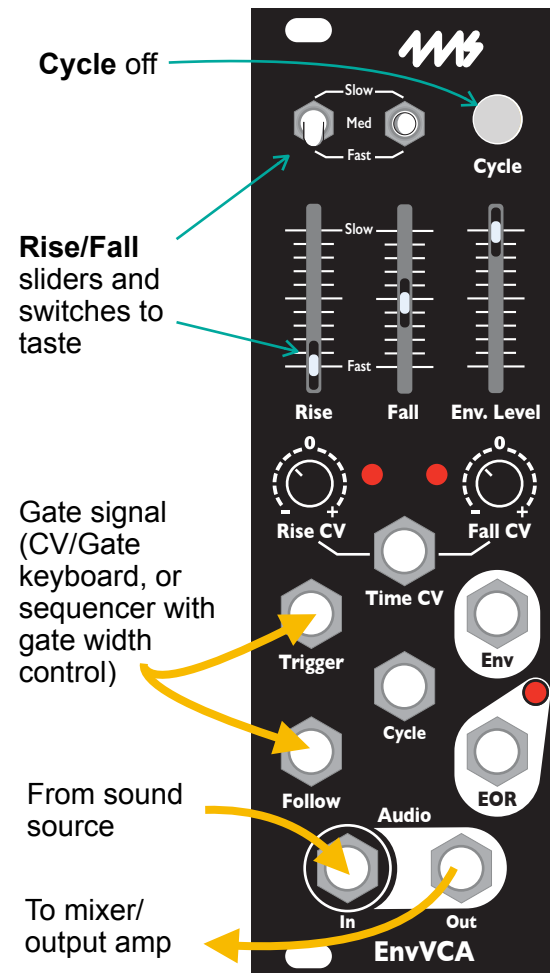

ASR Envelope

An ASR (attack-sustain-release) envelope is trapezoidal, with a rising slope (attack), a flat plateau (sustain), and a falling slope (release). See Figure 7. The width of the sustain stage is controlled by the width of the gate input: holding the gate high longer results in more sustain. This is in contrast to an AR (attack-release) envelope, which is the triangular shape that results from patching into the **Trigger** jack or using the **Cycle** button.

Patch the gate output of a CV/Gate keyboard to the **Follow** jack and the **Trigger** jack, using a mult or stacking cable. Patch an audio sound source into the **Audio In** jack, and run the **Audio Out** jack to a mixer or amp.

If using a keyboard as a gate signal, tapping a key quickly will result in a staccato note, while holding the key down longer will result in a longer note. Keep in mind that the minimum note length will always be determined by the rise and fall time parameters, no matter how short the gate input is.

Instead of a CV/Gate keyboard, you could also use the gate output of a sequencer that has control over the gate length (pulse width). Setting longer gate lengths for certain notes will emphasize or accent them in the sequence.

This patch works because we patched the gate into both the **Trigger** and **Follow** jacks. The **Trigger** jack ensures a complete envelope will output even if the gate width is very short. The **Follow** jack produces the sustain. If we had just patched a gate into the **Trigger** jack, the envelope would start to fall once the peak is reached and we would have no sustain. However, if the gate at the **Follow** input is still high, the envelope will remain high, creating the sustain

portion of the envelope. On the other hand, if we had only patched into the **Follow** jack, then a short gate width would only produce a complete envelope if the rise time parameter was very fast. Gates that are shorter than the rise time will result in an envelope that doesn't reach the peak, as seen in Figure 6 of the previous section. By patching the gate into both the **Trigger** and **Follow** jacks, we get complete envelopes regardless of the settings, as seen in Figure 7. Notice the width of the pulses and how they correlate to the sustain of the envelope output. The first pulse is not wide enough to produce any sustain because its width is lesser than the time it takes for the envelope to rise.

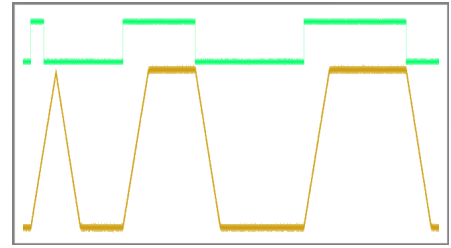

Figure 7: ASR patch: Gate length controls sustain length

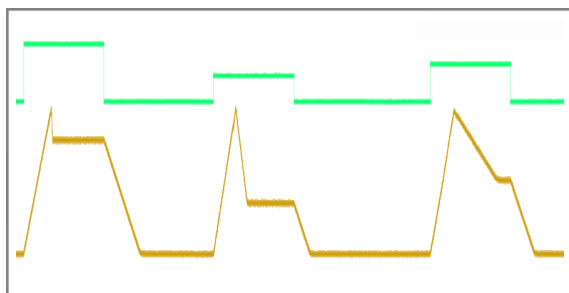
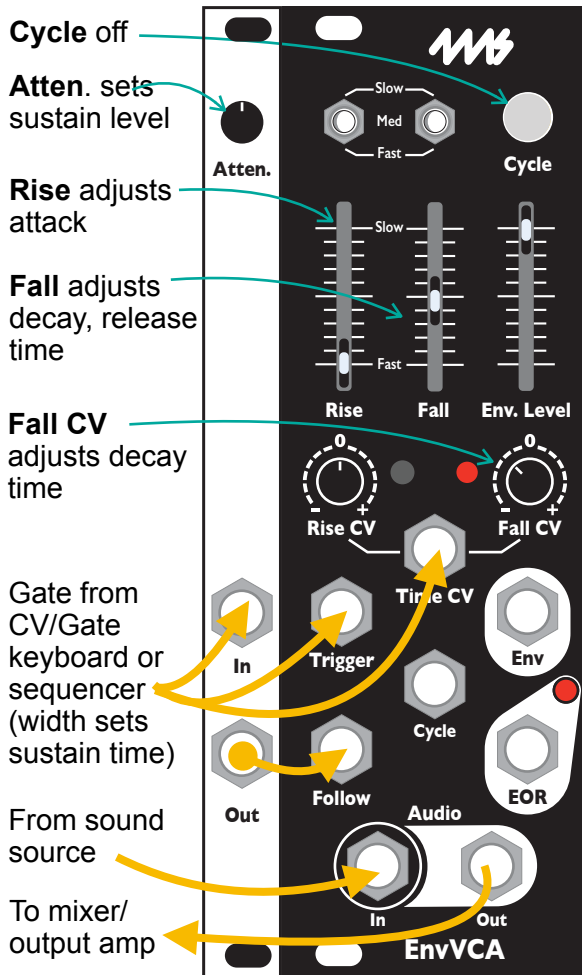

Figure 8: ADSR. Attenuator knob turned down in 2nd envelope to lower sustain level. Fall CV turned up in 3rd envelope to make decay slower.

ADSR Envelope

An ADSR (attack-decay-sustain-release) envelope is like an ASR envelope, except that it adds a fourth stage known as “decay” after the attack stage. After hitting the peak, an ADSR envelope “decays” to a sustain level less than the peak level. See Figure 8. This sustain level and the speed at which the envelope decays are controllable. The other stages (sustain and release) are identical to those in an ASR envelope.

We can generate an ADSR envelope with control over each stage by extending our ASR patch. This patch requires a way to attenuate the gate signal. An attenuator module is shown on the left.

Start with the ASR patch from the previous section. Unpatch the cable from the keyboard/sequencer gate output going to the **Follow** input, and instead patch it from the keyboard/sequencer gate output to the input of the attenuator module. Patch the output of the attenuator to the **Follow** jack.

Firing a gate will generate an envelope as shown in Figure 8. The rising edge of the gate will cause the envelope to rise to its peak and then fall until it reaches the level set by the **Follow** jack, which is controlled by the attenuator knob. For example, setting the attenuator knob such that the attenuator outputs a 3V gate will make the envelope sustain at 3V internally (resulting in a 6V sustain on the Env jack if the Env Level slider is all the way up). After the gate on the **Follow** jack goes low, the envelope will fall back to zero during the “release” stage.

We now have control over the attack or rise speed (**Rise** slider/switch), sustain length (gate pulse width), and sustain level (gate attenuator). However the decay time and the release time will always be the same, set by the **Fall** slider/switch.

To make this a true ADSR envelope, patch a cable from the mult or stacking cables on the gate output of the keyboard or sequencer to the **Time CV** jack. Make sure the keyboard/sequencer gate output still goes to the **Trigger** jack and attenuator module input. Now you can use the **Fall CV** knob to set the decay time relative to the release time. Turning it to the left of center will make the decay time faster than the release time, and vice-versa. The reason this works is that the decay stage occurs while the gate is high, and the release

stage occurs when the gate is low. Since the gate is patched into the **Time CV** jack, the position of the **Fall CV** knob only has an effect on the time when the gate is high, which is the decay stage. Note that adjusting the **Fall** slider or switch will change both the decay and release times.

Audio Filter

The **Follow** jack can be used as an exotic audio low-pass filter by taking advantage of its slew-limiting properties. First, the audio signal must be shifted up such that it's within the range of 0V to 5V. Typically a level shifter can be used to add the required DC offset. You may also need to attenuate the audio so that it's no more than 5V. Any signal outside this range will be clipped, resulting in harsh distortion.

Patch this adjusted audio into the **Follow** jack. Patch the **Env** output jack to your mixer/amp. Although this patch passes audio, it doesn't use the VCA section at all. To start, set the **Rise/Fall** sliders and switches to the fastest positions. Send a steady positive voltage into the **Time CV** jack and turn the **Rise CV** and **Fall CV** knobs all the way down.

At this point you should be hearing an audio signal that is similar to the original signal.

Now make the rise and fall times slower by adjusting the **Rise/Fall CV** knobs and sliders, or by adjusting the CV patched into the **Time CV** jack. As you do this, you should hear the audio get more muffled, as the slew becomes limited and higher frequencies can no longer pass.

To make more exotic sounds, try just adjusting the rise or the fall time. This will let the rising portions and falling portions of higher frequencies pass differently, creating some unique harmonics.

Waveshaper

By limiting the slew, waveshapes with sharper transitions can be altered to have smoother transitions. For instance, feeding a square wave into the **Follow** jack will produce a trapezoidal or triangular wave on the **Env** jack. Adjust the **Rise/Fall** sliders and switches to get a maximum amplitude output waveform while still performing the desired amount of waveshaping. These controls will need to be re-adjusted if the frequency of the waveform changes. You may be able to use the **Time CV** jack and **Rise/Fall CV** knobs to track the frequency and create a somewhat consistent variable-frequency wave shaper.

Portamento/Glide

The output of a CV/Gate keyboard or a sequencer is often a step-wave, meaning that the voltage jumps (or "steps") from one voltage to the next as the notes are played. When this is patched into a VCO, the result is a sequence of notes that jump from one pitch to the next. Adding in some slew causes the notes to "glide" from one pitch to the next. This effect is known as portamento or glissando. The **EnvVCA** can perform this effect by patching the step-wave into the **Follow** jack and taking the output from the **Env** jack. The amount of glide effect is controlled by the rise and fall times. If you're patched into the pitch input of a VCO, you can adjust the tuning with the **Env Level** slider. Keep in mind that the **EnvVCA** is not designed to be a precision portamento effect, so tuning will not be accurate over a wide range.

Generating Exponential and Logarithmic Envelopes

The **EnvVCA** can be used to generate exponential and logarithmic shapes by patching the **Env** output back into the **Time CV** jack. The **Rise CV** and **Fall CV** knobs can be used to independently control the shape of the rise and fall portions. For example, the waveforms in Figure 9 were generated by turning the **Rise CV** slightly left of center and the **Fall CV** slightly right of center. This will cause the rise shape to be exponential and the fall shape to be logarithmic. To make a logarithmic rise and exponential fall, we can just swap how our pots are set, turn the **Rise CV** to the right and the **Fall CV** to the left. Notice that the rise and fall times change dramatically when using this technique.

The **Shaped Dual EnvVCA** module from 4ms Company is the bigger cousin to the **EnvVCA**. This module has an exponential and logarithmic wave shaper, which can alter the wave shapes without changing the envelope timing.

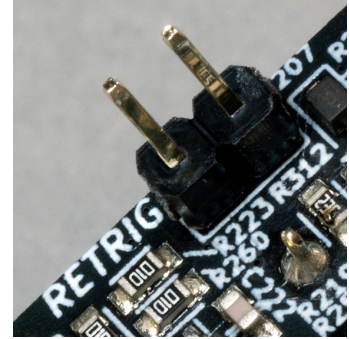

Figure 9: Log and expo shapes generated by patching Env into Time CV and adjusting Rise/Fall CV knobs

RETRIG Jumper

The **RETRIG** jumper on the back of the module changes the **EnvVCA's** behavior when it receives a trigger while an envelope is already running. When the jumper is not installed (factory default), triggers received as the envelope is rising will be ignored, and triggers received while the envelope is falling will make it begin rising again from its current voltage. When the jumper is installed, the **EnvVCA** will immediately restart the envelope when it receives a trigger, regardless of whether the envelope is rising or falling. When this happens, the envelope will immediately fall to 0V and begin to rise again. The sharp transition to 0V can cause clicking when used with the audio VCA section.

See the [Creating Envelopes](#) section for more details.



VCA Min Gain Trim pot

On the back of the module is a trimpot that can adjust the minimum VCA Gain. Typically, you will want to set this such that when the envelope is not running, you do not hear any audio bleeding through. However, setting the minimum gain too quiet means that when the **EnvVCA** is cycling, there are longer gaps between notes. That is, there is more time between envelope peaks where the sound is inaudible or barely audible.

At fully counter-clockwise, the VCA will provide -90dB of attenuation when the envelope is not cycling. This is the maximum amount of silence between notes when cycling and minimum amount of bleed. In the middle position (factory default), there is -80dB of attenuation. This provides a short amount of silence between envelope cycles, and low amount of bleed. Turning the trim pot all the way clockwise provides -30dB of attenuation when the envelope is stopped. This may be useful if you want less silence between cycles, and don't mind hearing some audio when the envelope is not cycling.

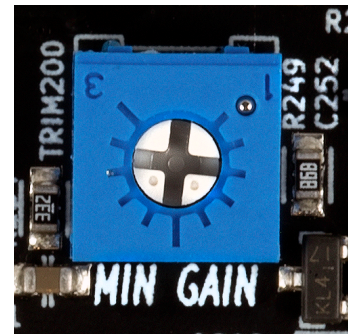

Electrical and Mechanical Specifications

- **EnvVCA**
 - 8HP Eurorack format module
 - 0.95" (24mm) maximum depth (includes power cable)
 - 10-pin Eurorack power header
- **Power consumption**
 - +12V: 85mA, -12V: 85mA
- **Audio/VCA**
 - 100k input impedance, 1k output impedance, DC-coupled
 - VCA gain range: -90dB to +0.9dB
 - DC to 20kHz, +/-0.1dB
- **Envelope Times**
 - Minimum rise or fall time: ~62us (8kHz max frequency)
 - Maximum rise or fall time: >150sec (typically 250-300sec per segment)
- **Jacks:**
 - Env jack: when fall time > 11ms: Min = -5mV to +40mV, Max = +9.5V
when fall time < 11ms: Min = -5mV to -1.2V, Max = +9.5V
 - Trigger jack: rising edge threshold = 2.5V
 - Cycle jack: rising edge threshold = 2.5V
 - Follow jack: active range = 0V to +5V
 - EOR jack: 0V to 5V gate output. Min stable PW = 1ms
 - Audio In/Out jacks: -10V to +10V maximum range without clipping